



INSTALLATION INSTRUCTIONS FOR SPECIALTY MULTI-PIECE SYSTEMS

	PAGE
Bench - Brisa [®] / Bayfield [®]	2
Bench - Highland Stone [®]	3
Column Cap - Brisa [®] / Bayfield [®]	4
Column Cap - Highland Stone [®]	5
Grill Island - Brisa [®] / Bayfield [®]	6
Grill Island - Highland Stone [®]	7
Mailbox - Highland Stone [®] / Bayfield [®]	8
Outdoor Theatre - Highland Stone [®] / Brisa [®]	9
Wall Cap End - Brisa [®]	10

BENCH

MULTI-PIECE SYSTEM

BASE COURSE

- Excavate an area 48 inches by 28 inches to a minimum depth of 8 inches.

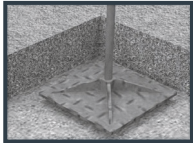

- Install base gravel to a compacted depth of 6 inches. Compact the gravel in 2 to 3 inch lifts to ensure proper compaction.

- Level the first end unit front to back and side to side keeping the unit six inches from each side of your excavated area. Make sure the textured sides are facing out.

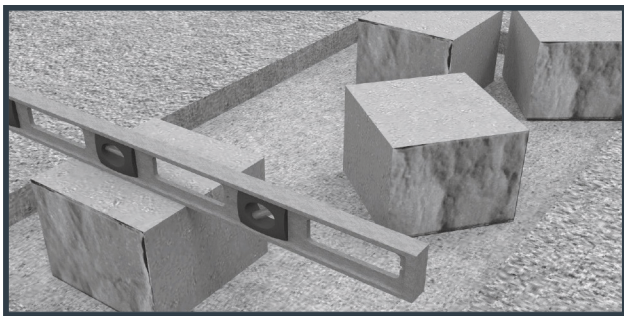

- Place the next end unit back to back with the first unit and level.
- Repeat this step for the other bench support. Make sure to level between the bench supports.

SUBSEQUENT COURSES

- Course two starts with a few dots of glue 3 to 6 inches apart on each unit.
- Set the four units of the second course on top of the first course making sure to line up the corners for a clean edge,
- Place glue on top of the second course.

BENCH

- Place the Landings™ step unit onto the two supports and center.

PROJECT INSTRUCTIONS

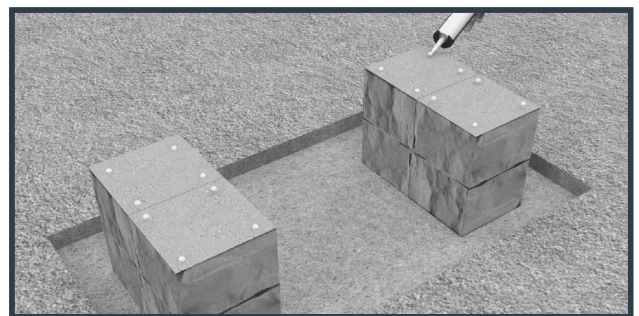
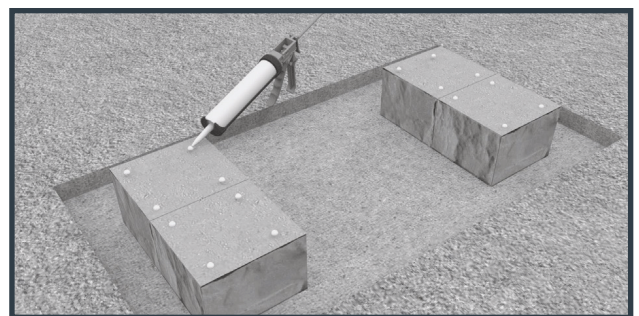
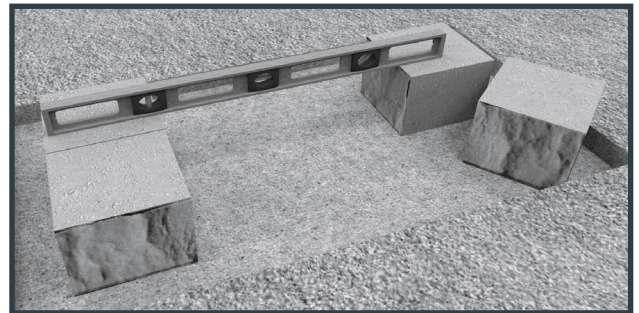

ANCHOR DIAMOND Group
5909 Baker Rd. Suite 550
Minnetonka, MN 55345

©2023 ANCHOR DIAMOND Group. All rights reserved.
AD23-005 01/23

MULTI-PIECE SYSTEM

PROJECT INSTRUCTIONS

BASE COURSE

- Excavate an area 48 inches by 24 inches to a minimum depth of 8 inches.
- Install base gravel to a compacted depth of 6 inches. Compact the gravel in 2 to 3 inch lifts to ensure proper compaction.
- Split six inches off of the manufactured end of each of the four column units as shown.

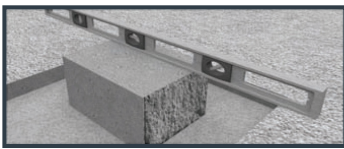

- Level the first end unit front to back and side to side keeping the unit six inches from each side of your

excavated area. Make sure the textured sides are facing out.

- Repeat this step for the other bench support. Make sure to level between the bench supports.

SUBSEQUENT COURSES

- Course two starts with a few dots of glue 3 to 6 inches apart on each unit.
- Set the two units of the second course on top of the first course making sure to line up the corners for a clean edge,

BENCH

- Place glue on top of the second course.
- Place the step unit onto the two supports and center.
- Finish the grade around the supports as needed.

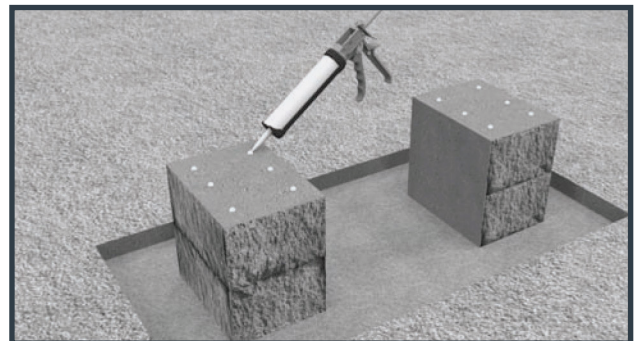
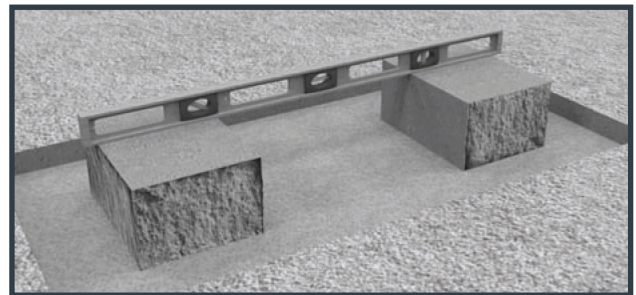
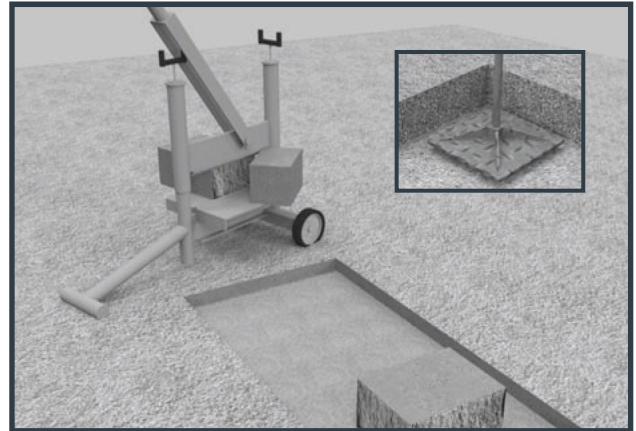

COLUMN CAP

MULTI-PIECE SYSTEM

BASE COURSE

- Excavate an area 39 inches square to a minimum depth of 9 inches.
- Compact base gravel in 2 to 3 inch lifts to ensure proper compaction to a total depth of 6 inches.
- Level the first column unit front to back and side to side, keeping the unit six inches from edge of excavated area. Make sure both textured sides are facing out.
- Level the remaining three units that make up the base course in the same manner.



COLUMN COURSES

- Place glue dots three to six inches apart on top of the base course blocks.
- Set the first unit of the second course maintaining a staggered bond, and align the corners for the best look. Complete the course with three more units.

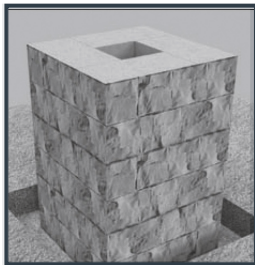

- Repeat course construction until you reach the desired height.

FINISH WITH CAP

- Complete the column with a column cap that is at least three inches wider than the column. Glue in place.

PROJECT INSTRUCTIONS

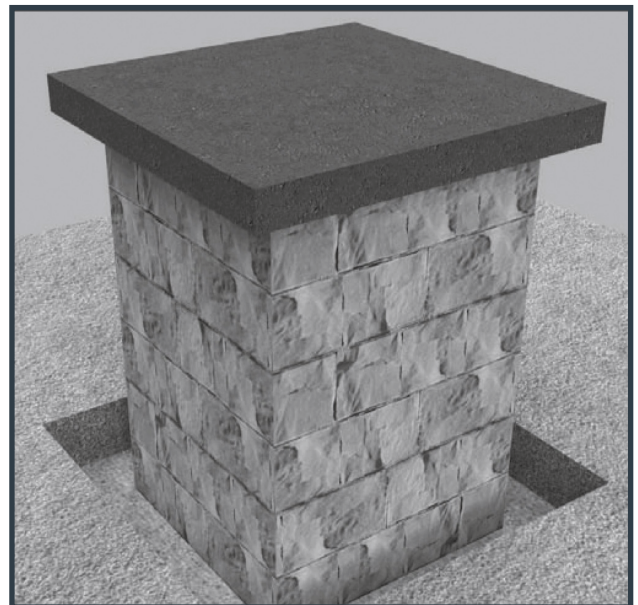
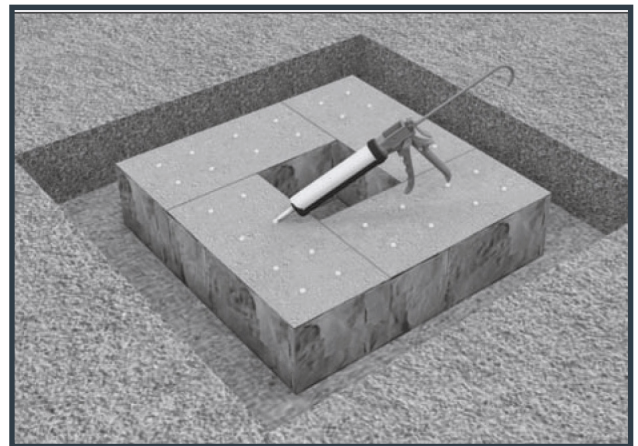
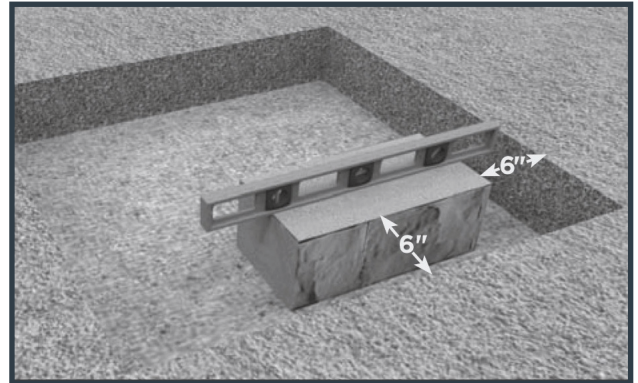

COLUMN CAP

MULTI-PIECE SYSTEM

BASE COURSE

- Excavate an area 39 inches square to a minimum depth of 9 inches.
- Compact base gravel in 2 to 3 inch lifts to ensure proper compaction to a total depth of 6 inches.
- Level the first column unit front to back and side to side, keeping the unit six inches from edge of excavated area. Make sure both textured sides are facing out.
- Level the remaining three units that make up the base course in the same manner.

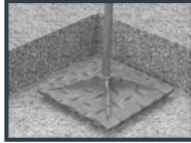

COLUMN COURSES

- Place glue dots three to six inches apart on top of the base course blocks.
- Set the first unit of the second course maintaining a staggered bond, and align the corners for the best look. Complete the course with three more units.



- Repeat course construction until you reach the desired height.
- Remove any texture misalignments with a mason hammer.

FINISH WITH CAP

- Complete the column with a column cap that is at least three inches wider than the column. Glue in place.

PROJECT INSTRUCTIONS

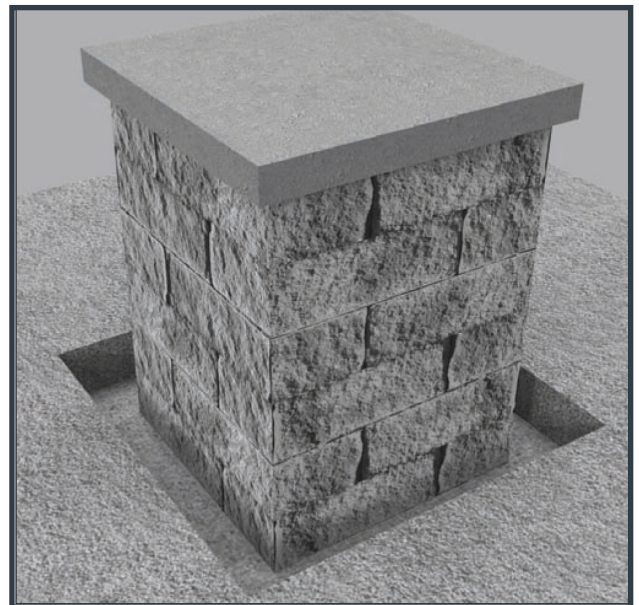
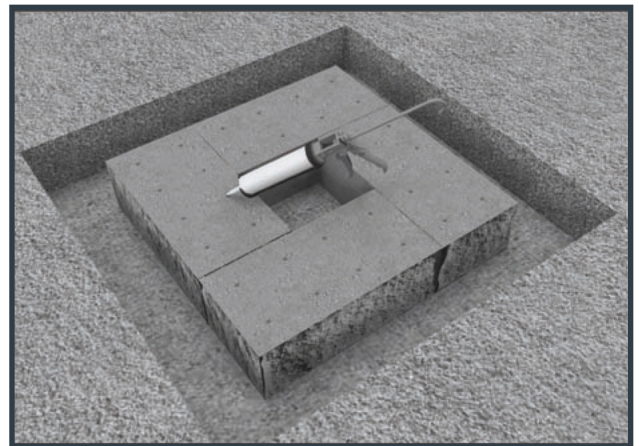
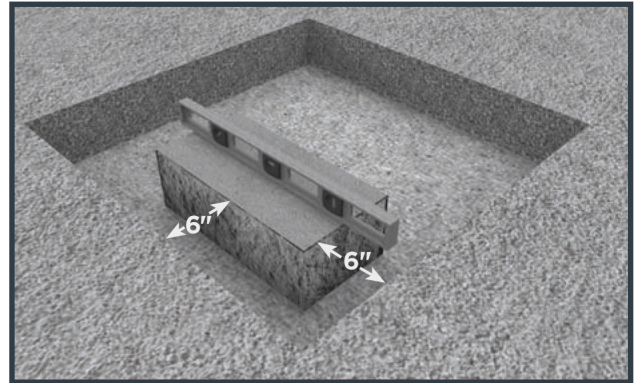

GRILL ISLAND

MULTI-PIECE SYSTEM

INITIAL COURSES

- Lay out rows 1-3 as shown gluing between each course.

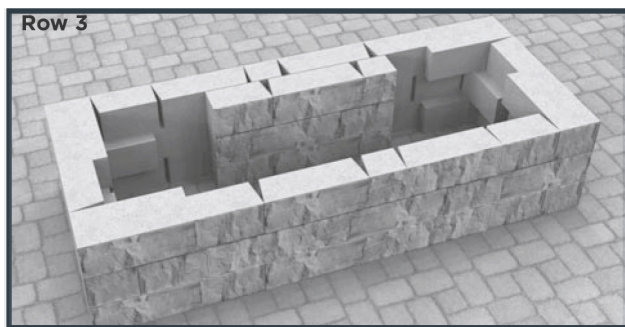
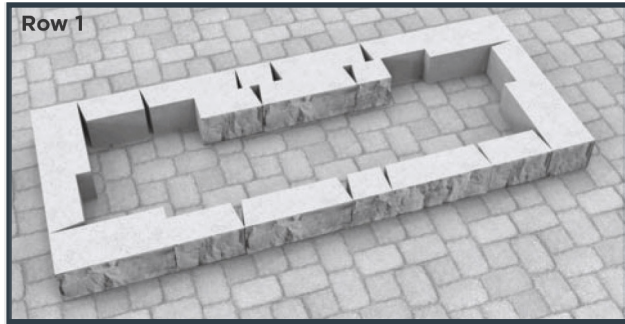

- Lay out row 4 cutting a 6" unit to length to fit the grill. (c)

PROJECT INSTRUCTIONS

GRILL INSERT

- Layout the caps as shown cutting to fit the opening using the 2 cap ends (a) to give texture on the exposed areas.

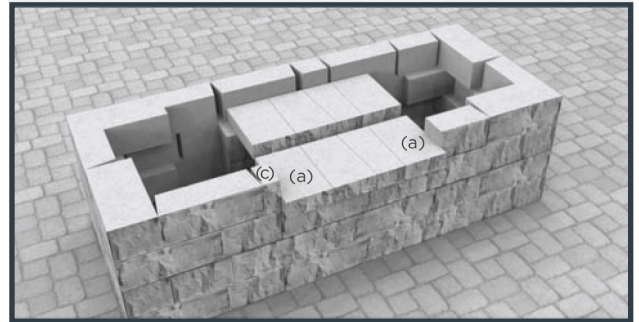

- Layout row 5, again cutting a 6" unit to fit. (c)

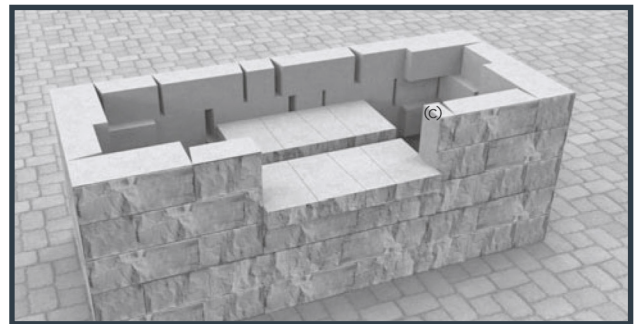

FINISH

- Add your selected countertop to the surround.
- Install your grill.



ANCHOR DIAMOND Group
5909 Baker Rd. Suite 550
Minnetonka, MN 55345

©2023 ANCHOR DIAMOND Group. All rights reserved.
AD23-005 01/23

MAILBOX

MULTI-PIECE SYSTEM

INITIAL COURSE

- Excavate an area 12 inches deep and 12 inches wider than your project footprint.
- Install base gravel to a compacted depth of 6 inches. Compact the gravel in 2 to 3 inch lifts to ensure proper compaction.

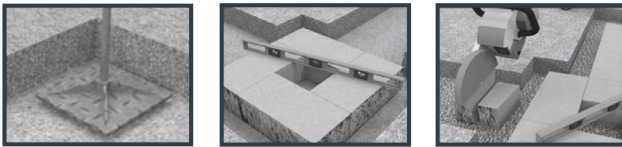
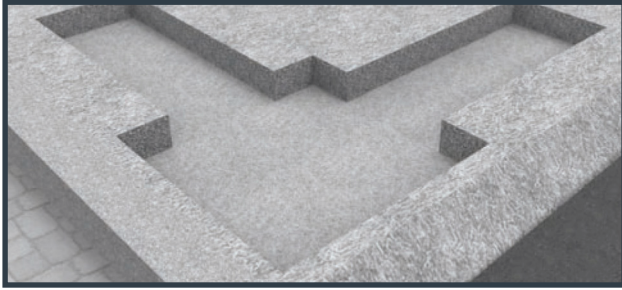

- Starting with the column, level the first unit front to back and side to side keeping the unit six inches from each side of your excavated area. Make sure the textured sides are facing out. Continue leveling in this manner until the 4 column units are installed. Place the next end unit back to back with the first unit and level.
- To build the wing walls, start with a unit cut in half. Place the cut side of this unit tight against the column unit perpendicular to the face and level in place. Continue leveling units to reach your desired length. Repeat for the additional wing wall.

Tip: Use the other half of the cut unit to start the second wing wall.

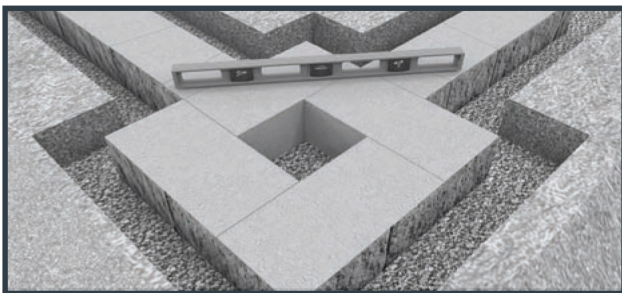

PROJECT INSTRUCTIONS

- To end the wing wall you need to split a unit. Use a hammer and chisel or guillotine splitter to split a unit to finish the wall at your desired length.

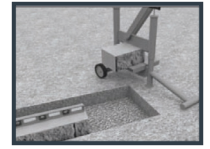

ADDITIONAL COURSES



- Course two starts with a few dots of glue three to six inches apart on each unit.

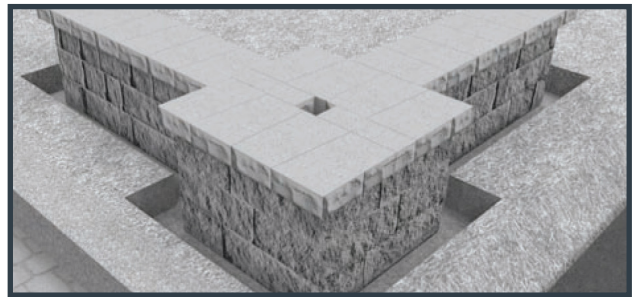

- Set the four units of the second course of the column on top of the first course making sure to line up the inside edges to maintain a level column. Repeat this up to the mailbox course.
- Repeat the steps to build the wing walls.
- Cap the wing walls and glue in place. Add caps around the column to give a banding effect. Cut caps to fit as needed.

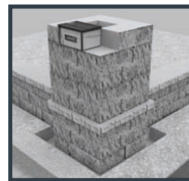

- Place the mailbox at your desired height. Secure with construction adhesive or screws. Place column units around the mailbox and cut as needed for a finished look.



- Add column units to achieve the desired height.
- Finish the project with an Anchor™ column cap.

ANCHOR DIAMOND Group
5909 Baker Rd. Suite 550
Minnetonka, MN 55345

©2023 ANCHOR DIAMOND Group. All rights reserved.
AD23-005 01/23

OUTDOOR THEATRE

DEVELOPED BY
ANCHOR
DIAMOND
WALL INDUSTRY EXPERTS

MULTI-PIECE SYSTEM

CONSOLE BASE

- Remove the rear lips from the retaining wall units and layout on the patio as shown
- Continue with course two and three knocking off the lips and gluing each course vertically.
- Cap the console base with the ShortCut® sculpted cap.



CONSOLE TOP

- Apply adhesive and install the freestanding wall units as shown. Leave the opening wide enough to accommodate the TV you are installing. Cut pieces as needed to fit layout.
- Continue installing the freestanding wall units to reach the height of the TV.
- Cap the unit with natural stone or a poured concrete slab.

PROJECT INSTRUCTIONS

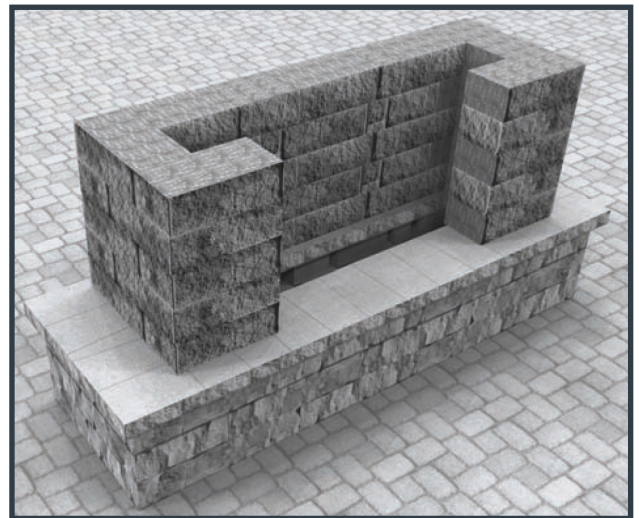

ANCHOR DIAMOND Group
5909 Baker Rd. Suite 550
Minnetonka, MN 55345

©2023 ANCHOR DIAMOND Group. All rights reserved.
AD23-005 01/23

WALL CAP END

DEVELOPED BY
ANCHOR
DIAMOND
WALL INDUSTRY EXPERTS

MULTI-PIECE SYSTEM

INSTALLATION INSTRUCTIONS

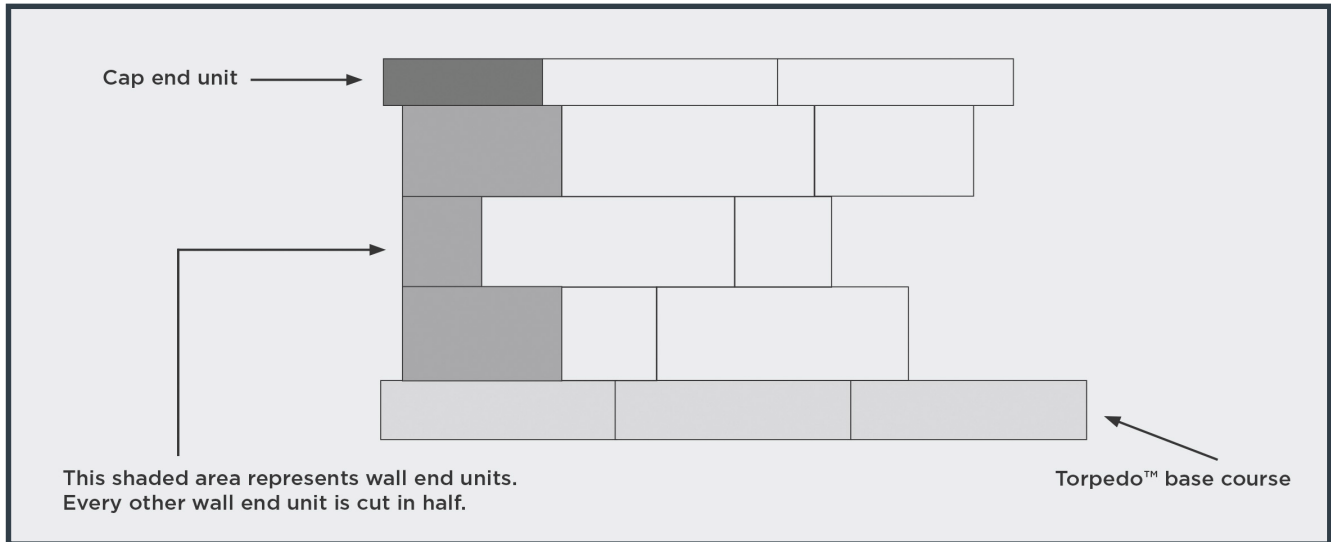

END A WALL WITHOUT A COLUMN

End installation pattern next to a wall end unit if the wall does not end with a column.

Cut every other wall end unit in half. Glue all units.

If a wall end unit is not available in your market, either:

- See your dealer for a template to guide cutting corner/column and wall units to finish end; or
- Visit anchordiamond.com for installation instructions and construction details.



FINISH WITH CAP END UNIT

- If a cap unit needs to be cut, cut an interior cap, not a cap end unit. Place and glue cap end to finish capping wall.
- Cap end unit may also be used for capping a corner and for step-downs.
- Visit anchordiamond.com for installation instructions and construction details.



ANCHOR DIAMOND Group
5909 Baker Rd. Suite 550
Minnetonka, MN 55345

©2023 ANCHOR DIAMOND Group. All rights reserved.
AD23-005 01/23